



Recognized worldwide as the finest quality film developing equipment made

Made in Germany from Chrome-Nickel steel which is unbreakable, corrosion-proof, and easily brought to correct temperature.

Complete system includes Reels, Tanks, and Reel Loaders.

Designed to assure rapid, efficient, trouble-free film developing, with consistent, optimum results.

Kindermann Stainless Steel Developing Tanks

- Heavy gauge chrome-nickel steel is unbreakable and corrosion-proof.
- Fast, efficient, internal flow-control saturates all the film instantly for even development.
- Leakproof, snug-fitting polyethylene tops for immersion agitation.
- Quick-pour top allows tanks to be rapidly filled and emptied in daylight.

Tanks come with cover and cap. Master carton: 10



	Reel Capacity	Inside Dia.	Hgt.	Capacity	Mfr#
EKM363	1-35mm	85mm	55mm	250ml	3363
EKM364	2-35mm or 1-120	85mm	88mm	450ml	3364
EKM253	Replacement cover & cap for tanks				3253
EKM875	Replacement tank cap only				9960
EKM171	Filter funnel to fit tank cover				3310
EKM3196	Replacement lift rod for tank EKM184				3196

Kindermann Stainless Steel Developing Reels

- Made of chrome-nickel steel: unbreakable, chemical resistant, easy to clean.
- Only fractions of a millimeter of film edge touches the reel, preventing damage.
- Strong, rigid construction with center core, keeps reel aligned and grips end of film for trouble-free loading. Can be used even when wet.

Master carton: 10

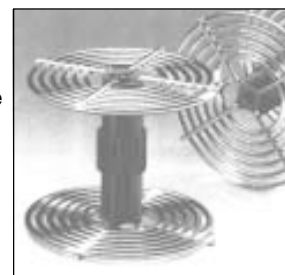

		Diameter	Mfr#
EKM117	35mm Stainless Steel Reel	81.5mm	3117
EKM119	120 Stainless Steel Reel	79mm	3119

Kindermann Film Loaders

The quickest, safest method for loading film onto Kindermann reels. Prevents scratches, creases and fingerprints. Film is guided evenly only at the outer edges of the perforation.

Master carton: 10



EKM326	35mm Film Loader	3326
EKM329	120 Film Loader	3329
EKM219	110 Film Loader	3219

PERSONAL SERVICE IS OUR #1 PRIORITY



East: 111 Asia Place, Carlstadt, NJ 07072

(201) 939-7722

FAX: (201) 939-7782

West: 4055 W. Shaw Ave.#105, Fresno, CA 93722

(559) 277-3572

FAX: (559) 277-3574

HEWES Stainless Steel Reels

Easy loading, extra durable, and corrosion resistant. Custom tail clips prevent troublesome unwinding during processing. Smooth polished surface prevents problems with scratching and kinking of film. For use in all processing equipment or tanks that utilize standard size reels. The outside diameter of all reels is 3³/₈".



		Diameter
EKC009	For 35mm	82.5mm
EKC012	For 120mm	82.5mm
EKC014	For 220mm	83.5mm

samigon®

Stainless Steel Developing Reels

Unbreakable, satin-finish, stainless steel. Rigid core and cross braces keep reel aligned. Clip holds film end to make loading easy. Individually boxed. Master: 10.

		Diameter
ESA311	For 35mm	81.5mm
ESA313	For 120mm	80mm
ESA316	For 220mm	82.5mm



Stainless Steel Developing Tanks & Lids

Made of high grade stainless steel. The cap has a convenient finger tab that makes the removal of chemistry quick and struggle free.

		Inside Dia.
ESA342	For 35mm	85mm
ESA346	For 2-35 or 1-120	85mm
ESA348	7" for 4-35 or 2-120, w/lift rod	85mm
ESA350	12" for 8-35 or 4-120, w/lift rod	83.5mm



Stainless Steel Developing Tanks w/ PVC Tops

Unbreakable, satin-finished, stainless steel. PVC tops fit snugly, permitting inversion agitation. Provides fast daylight fill for even development. Individually boxed.

		Inside Dia.
ESA340	For 1-35mm Reel	85mm
ESA345	For 2-35 or 1-120	85mm
ESA347	7" for 4-35 or 2-120, w/rod	85mm
ESA349	12" for 8-35 or 4-120, w/rod	85mm
ESA357	Replacement Lift Rod for 7" tank	
ESA358	Replacement Lift Rod for 12" tank	
ESA359	PVC Cover for all stainless steel tanks	



samigon®

Universal Developing Tank with 2 Multi-Format Reels

For B&W or color film. Made from impact resistant plastic. Includes 2 self-feed, multi-format reels. The tank will hold 2- 35mm or 2- 126 films or 1- 127, 120 or 220 films. Chemical requirements are molded into tank base. The self-loading heat resistant reels allow for easy loading and are compatible with Paterson System 4.

ESA321 Universal Developing Tank with 2 Reels

Compatible with Paterson System 4



Easy Loading Reels



samigon®

Multi-Format, Autofeed Developing Reels

Replacement reels for use with the Samigon Universal Developing Tank or Paterson System 4. They are manufactured from a high grade plastic compound and are heat resistant. The reels will adjust to take 35mm, 126, 127, 120, and 220 film. New design makes loading even easier and more foolproof. 3³/₈"(95mm) diameter. 1" core.

ESA325 Extra Developing Reels for ESA321

yankee Master Developing Tank

Includes two adjustable reels. Develops all popular roll film sizes: 110, 126, 120, 220, 620, 828, 16mm & 35mm. Develops 2 rolls of 110/16mm or 35mm, and one roll of 120 at a time. Extra wide-mouth allows filling and emptying in seconds.

Reels feature "snap-in" film size adjustments; no twisting, no spacers or clips required.

Ball bearing device in reels, for "walk-in" loading. Unbreakable translucent reels.



EYA205 Master Developing Tank

RFM-18

FOR FAST DELIVERY CALL TOLL FREE!

EAST
1-888-ARGRAPH
OR 1-800-526-6290

WEST
1-888-WESTARG
OR 1-800-323-9069

PFAFF Wat-Air Roll Film Washers

Wat-Air Roll Film Washers speed up washing time by creating & maintaining constantly controlled turbulence through out the wash cycle. Wat-Air is made of Cycloac (a virtually unbreakable plastic) and transparent acrylic. The unit is fully self-contained and does not require external plumbing. Comes complete with 30" hose, built-in water filter, and connections for faucets with garden hose threads. Holds stainless steel reels up to 3½" (87mm) diameter (Samigon, Kindermann, Hewes, etc.)

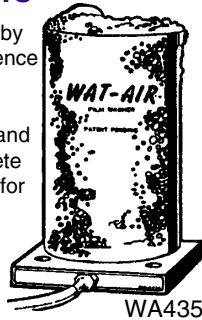

EPF301 4-35 or 2-120

WA435

Testrite Film Wipers

Insures clean, streak-free negatives. 3" sponges are attached to flexible aluminum handle. Polybagged.

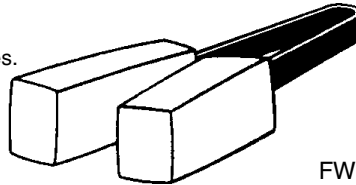

ETE307 Film Wiper

FW

samigon® Cotton Gloves

High quality, washable cotton gloves. For handling film, negatives, slides, etc. 12 pair to poly pak. One size fits all.



ESA370 Pk/12 pair Cotton Gloves

samigon® Plastic Film Squeegee

Compact, spring operated film wiper. 4¼" long. Ribbed soft rubber blades. Overall length 7½". Molded of yellow plastic. Blister packed.



ESA275 Plastic film squeegee

samigon® Changing Bags

A "Portable Darkroom" that consists of double-zippered inner and outer cloth bags with elastic sleeves. 100% lightproof (even in bright sunlight). Provides ample working space for loading cartridges and opening cameras in emergency situations. Can also be used when working with cut-film holders and developing tanks. Boxed with pegboard cutout. Master: 10.

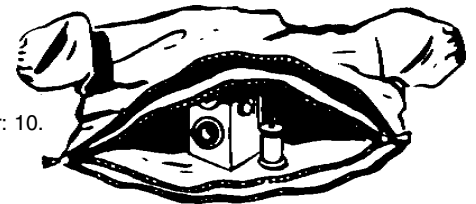

ESA917 Small, 17" x 16"

ESA927 Large, 27" x 30"

Proofers/Paper Safes/Filters

Pfaff Paper Safes

Lighttight protection for up to 100 sheets of paper. Molded of high-impact black plastic. Hinged door with metal latch for easy opening and closing. Rimmed top and recessed bottom permits stacking.

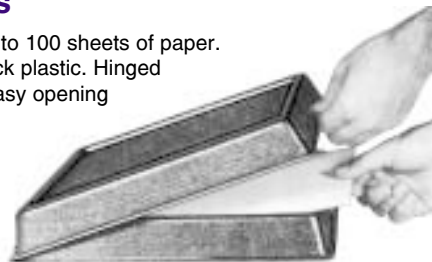

EPF951 8 x 10 Paper Safe
EPF953 11 x 14 Paper Safe

KPS8-10
KPS11-14

CPM/DELTA Proof-File 11 x 12 Jumbo Proofer

Oversized to accept all plastic file pages. Allows proofing to be done without removing negatives from preserver. Thick optical glass for superb clarity. Heavy 20 gauge steel base. Cork base. Cushion of dense 130lb. foam. Can be used as a borderless easel or copy board.

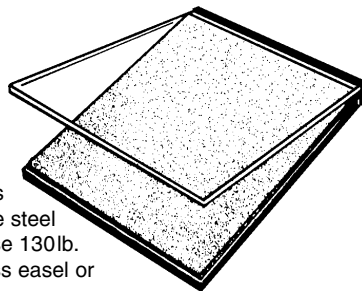

ECP138511 11 x 12 Proofer

13210

CPM/Delta Paper Safe-T Bags

10 x 14 double thick bag with extra carbon black pigment stores film and paper light tight. Pk/5 includes 5 labels plus free 8 x 10 bag.

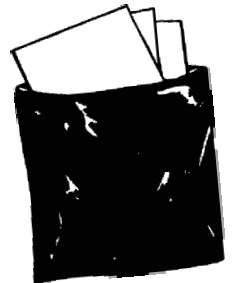

ECP365 Paper Safe-T Bag w/labels

13510

samigon® System 7 Polycontrast Filters

(For use with any variable grade black and white paper)

An economical and durable filter system for use with Kodak Polycontrast and Ilford multigrade paper. Set of 7 filters housed in individual opaque vinyl sleeves. 3" square, 1/16" thick plastic filters, range from 1 to 4 (with 1/2 increments) allowing the full range of contrast control. Filters can be trimmed with scissors to fit into the filter drawer of most enlargers. In poly bag for pegboard display.



ESA901 System 7 Polycontrast Filters

PERSONAL SERVICE IS OUR #1 PRIORITY



East: 111 Asia Place, Carlstadt, NJ 07072

(201) 939-7722

FAX: (201) 939-7782

West: 4055 W. Shaw Ave.#105, Fresno, CA 93722

(559) 277-3572

FAX: (559) 277-3574

Stainless Steel Clips - Puncture Grip



Testrite

Light, non-weighted.
Sold in cards of 12.



Samigon

1 weighted, 1 non-weighted.
Sold in box of 10 pairs.

ETE312 Testrite, Cd/12 SSFC
ESA360 Samigon, Bx/10 pair

CPM/Delta Gorilla Grip

Strong action film clips with ridged surface.
Display/140.

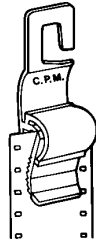

ECP293 Disp/140, Gorilla Grips 12510



Plastic Film Clips Spring Type, Positive Grip

3½" long. 1 weighted, 1 non-weighted,
Stainless steel springs.
Blister Pack of 2.
Master:10.



ESA362 Samigon Clips, Blister Pk/2



35mm Film Retriever

Designed for quick, safe retrieval of 35mm film
leader rewind into film cassette of 20 or
36 exposure film. Use in bright light
without exposing film. Made of stainless
steel. Smooth edges will not scratch film.

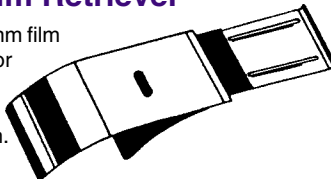

ESA367 35mm Film Retriever



Easy to use design for quick and safe retrieval of 35mm film with
out a scratch. Can be used in the in bright light without the risk of
exposing film.



ESA365 Pro Film Retriever

Watson Bulk Film Loader

Save up to 50% on film costs, gain more consistent results by using
same emulsion batch, and load your cassettes with the number of frames
which suits you! Each 100ft. roll of film produces 18-36 frame
cassettes. Load any brand of 35mm color or B & W film.
Features accurate frame counter, hinged access
locking door to prevent accidental opening,
and loading method which makes film
scratching impossible. Lightweight
and durable. Instructions included.



EPF921 Watson Bulk Film Loader W-100
EPF923 Spare crank for W-100 loader



Metal Film Reload Cartridges

Top-quality, all-new, all-metal cartridges.
Easy to use - just tap the protruding end on a firm
surface and the cover lid will pop off. Load spool
in dark and snap on cover lid to close securely.
Data space for film type, ISO, exposures.
Bulk box/100. Master:16 boxes. Pegboard
pack/10.

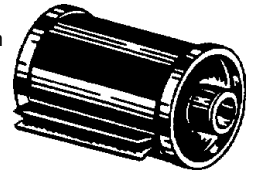

ESA903 Bx/100, Metal Reload Cartridges
ESA906 Pk/10, Metal Reload Cartridges



Metal Film Reload Cartridges (DX-400)

Same as ESA903 but DX Coded at ASA
400 for the most popular films used at
newspapers, and photo courses -
TRI-X and TMAX 400.
Bulk box/100. Master:16 boxes.
Pegboard pack/10.

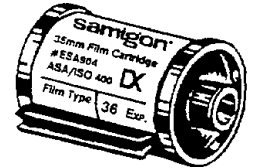

ESA904 Bx/100, Metal Reload Cartridges-DX-400
ESA907 Pk/10, Metal Reload Cartridges-DX-400



Reload Cartridges - Plastic

Plastic 35mm reload cartridges with screw-on end cap.
Includes pressure sensitive labels for film identification.
Bulk box/100. Master: 16 boxes.
Blister pack/5.



ESA902 Bx/100, Plastic Reload Cartridges
ESA905 Pk/5, Plastic Reload Cartridges

FOR FAST DELIVERY CALL TOLL FREE!

EAST
1-888-ARGRAPH
OR 1-800-526-6290

WEST
1-888-WESTARG
OR 1-800-323-9069

Pana-Vue® Archival Pages

Archival quality • Acid-Free • No PVC • Safe for long term storage • Designed for 3-ring binders and hanging files
View, organize, and preserve your negatives, slides, and prints • Protect from fingerprints, scratches, and dust

Negative Pages

35mm

Item#	Style#	Description	Pack	Cases
35mm Negative Pages				
EPA410	35-6x4	6 strips of 4 frames (total 24)	100	15
EPA409	35-6x4	6 strips of 4 frames (total 24)	25	50
EPA401	35-7x5	7 strips of 5 frames (total 35)	25	50
EPA400	35-7x5	7 strips of 5 frames (total 35)	100	15
EPA399	35-6x6	6 strips of 6 frames (total 36)	25	50
EPA398	35-6x6	6 strips of 6 frames (total 36)	100	15
EPA412	35-7x6	7 strips of 6 frames (total 43)	25	50
EPA407	35-7x6	7 strips of 6 frames (total 43)	100	15



35-6x4

EPA409 (pk/25)
EPA410 (pk/100)
Holds six 4 frame 35mm strips, 24 frames total.
Contact prints on 8 x 10

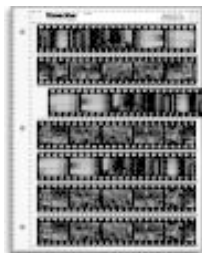

35-7x5

EPA401 (pk/25)
EPA400 (pk/100)
Holds seven 5 frame 35mm strips, 35 frames total.
Contact prints on 8 x 10



35-6x6

EPA399 (pk/25)
EPA398 (pk/100)
Holds six 6 frame 35mm strips, 36 frames total.

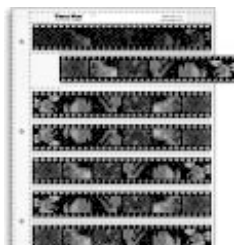

35-7x6

EPA412 (pk/25)
EPA407 (pk/100)
Holds seven 6 frame 35mm strips, 42 frames total

120

Item#	Style#	Description	Pack	Cases
120 Negative Pages				
EPA446	120-3x4	3 strips - total 12 frames	25	50
EPA445	120-3x4	3 strips - total 12 frames	100	15
EPA403	120-4x3	4 strips - total 12 frames	25	50
EPA402	120-4x3	4 strips - total 12 frames	100	15
EPA420	120-4x3/67	4 strips - 6x7cm (total 12)	100	15
EPA418	120-9	9 single sleeved frames up to 6x7cm	25	50
EPA418C	120-9	9 single sleeved frames up to 6x7cm	100	15

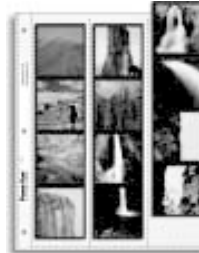

120-3x4

EPA446 (pk/25)
EPA445 (pk/100)
Holds 12 frames of 6 x 6cm, 9 frames of 6 x 7cm, or 15 frames of 6 x 4.5cm.
Contact prints on 8 x 10

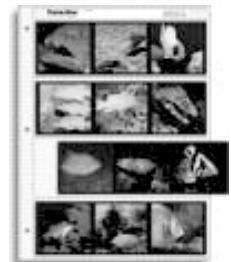

120-4x3

EPA403(pk/25)
EPA402(pk/100)
Holds 12 frames of 6 x 6cm or 8 frames of 6 x 7cm.
Contact prints on 8 x 10



120-4x3/67

EPA420 (pk/100)
Holds 12 frames of 6 x 7cm



120-9

EPA418 (pk/25)
EPA418C (pk/100)
Holds 9 sleeved frames of 120 film up to 6 x 7cm, or 18 2½ x 3½ prints or collectable cards.

For More Pana-Vue Archival Pages see page F-8, For Pana-Vue Print Pages see page G-20

PERSONAL SERVICE IS OUR #1 PRIORITY



East: 111 Asia Place, Carlstadt, NJ 07072

(201) 939-7722

FAX: (201) 939-7782

West: 4055 W. Shaw Ave.#105, Fresno, CA 93722

(559) 277-3572

FAX: (559) 277-3574

Time-O-Lite Professional Timers, P-72 Series

For exact, fully automatic timing of all darkroom work. Interval and remaining time indicators. Safelight goes out when push button is operated. Luminous dial, line cord, enlarger and safelight outlets are polarized with a two wire and ground connection. Accepts model FS-59 foot-switch (EIT972) for remote operation. Heavy duty synchronous motor.



Specifications: 1000 watt load capacity, UL listed, CSA approved for 120v-ac 50 or 60 Hz only.

	<u>Max. Time</u>	<u>Dial Calibration</u>	
EIT902	60 sec.	1 sec.	P-72-60S

Time-O-Lite Enlarging Timer GR-90

Economy priced precision timer incorporates an accurate synchronous motor drive, with a simplified automatic reset timing mechanism. A toggle switch controls power to the load receptacle, permitting either timed or constant output. Features luminous dial, chemically resistant Lexan case, wall or table mounting and polarized two wire and ground line cord and receptacle, push button start with automatic reset.



Specifications: 750 watt load capacity, UL & CSA approved for 120 volts, 60 cycles. Maximum time of 60 sec., Dial calibration of 1 sec. increments.

EIT921	Enlarging Timer	GR-90
--------	-----------------	-------

Time-O-Lite Master Timer

Interval and remaining time indicators. Easy-to-read luminous dial. Safelight goes out when push button is operated. Line cord, enlarger safelight outlets are polarized with a two wire and ground connection. Heavy-duty synchronous motor. Push button start with automatic reset.



Specifications: 750 watt load capacity, UL & CSA approved for 120 volts, 60 cycles. Max. time of 60 sec., Dial calibration of 1 sec. increments.

EIT923	Master Timer	M-72-60S
--------	--------------	----------

Time-O-Lite Enlarging Timer M72R

Same as above except includes receptacle for safe light power cord.

EIT924	Enlarging Timer	M-72R
--------	-----------------	-------

Time-O-Lite AutomTime-O-Lite Automatic Reset Timer

Features extremely accurate and durable timing mechanism with a unique reset feature.

Two pilot lights on the front of the timer indicate when the unit is timing, and when it has completed the time cycle.

Buzzer provides audible signal at the completion of the time interval.

UL listed & CSA approved.



	<u>Max. Time</u>	<u>Dial Calibration</u>	
EIT955	60 min.	1 min.	SR59-1H

Time-O-Lite Darkroom/Laboratory Interval Timer

Features a large 7" diameter dial with large luminous numerals. Set any combination of sec. & min. from 1 sec. to 59 min./59 sec. and it will automatically control the enlarging. Starts and stops appliances at pre-selected times. Operates up to 750W electric circuit for time interval.

Provisions for remote buzzer, light plug-ins or solenoid valves. Serves as a signaling timer or countdown clock with loud, built-in buzzer. It has grounded 3-wire line cord & receptacles.



Specifications: The EZC is synchronous motor-driven manual-set interval timer with a 3-way ON/OFF toggle switch which controls power supply to BLACK receptacles (to operate electric circuit during time interval) and to RED receptacle (to provide power after time interval). UL listed and CSA approved for 120 volts, 60 cycles.

EIT925	Darkroom/Laboratory Interval Timer	EZC-73
--------	------------------------------------	--------

Time-O-Lite Foot Switch

Dual-purpose foot switch provides remote control for the Professional P-72 Automatic Timer, or an enlarger or printer without the timer. Compact, non-skid design. Heavy-duty ten foot line cord, with adapter for direct connection to enlarger. 500 watt capacity. UL listed & approved.

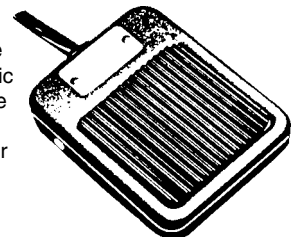

Specifications: 115 volts, AC. only, 500 watts capacity.

EIT972	Foot Switch	FS-65
--------	-------------	-------

FOR FAST DELIVERY CALL TOLL FREE!

EAST
1-888-ARGRAPH
OR 1-800-526-6290

WEST
1-888-WESTARG
OR 1-800-323-9069

PEAK ENLARGING FOCUSERS

Peak focusers are precision instruments which ensure extremely sharp focusing of your photo-enlarger not only at the picture center portion but also at any position within the picture area. With the aid of these focusers, you will be able to maximize the performance of your enlarger and obtain pictures of unparalleled sharpness.

Peak Enlarging Focuser I #2000

This model employs a Kellner's loupe and a 86mm long mirror. Since the loupe portion is arranged to allow swinging, focusing is possible within the range in which the optical axis of the enlarger lens forms an angle of about 30° with the optical axis of the loupe. It has an aluminum die-cast body with a black-paint finish.



EPK200 Peak Enlarging Focuser I 2000
 EPK200M Replacement mirror for Focuser I

Peak Enlarging Focuser II #2020

This model has the same basic design as Model I. Through the use of the special design wide-field loupe, focusing is possible within the range in which the optical axis of the enlarger lens forms an angle of about 20° with the optical axis of the loupe, while the loupe and pattern plate are being securely fixed. For the body of this model, glass-fiber-impregnated resin is used.



EPK202 Peak Enlarging Focuser II 2020
 EPK202M Replacement mirror for Focuser II

Peak Enlarging Focuser III #2030

This model has the same basic design as Model I and II. Focusing can be accomplished smoothly within the range in which the optical axis of the enlarger lens forms an angle of about 10° with the optical axis of the focuser.



EPK203 Peak Enlarging Focuser III 2030
 EPK203M Replacement mirror for Focuser III

Magnasight Enlarger Focuser

Simply place on your enlarging easel and focus the magnified image through the powerful 2" viewing lens. Magnasight helps produce needle-sharp, dust-free enlargements with a minimum of effort. Can be viewed from a reading distance. Operator may stand erect—no squinting or stooping. Made of metal with weighted base. Each instrument has glass optics and is individually adjusted for perfect focus.

EMA011 Enlarger Focuser



Micro-Sight Enlarging Focuser

This precision instrument, with an achromatic lens, magnifies the grain approx. 275 times for 11 x 14 enlargement, thereby bringing the grain into clear focus. May be used with even the brightest safelights. Features the "Mikodot Superbrite" front surface mirror and a hairline reticle suspended in air. All metal with weighted base.

EMS022 25X Enlarging Focuser



Mini-Sight Enlarging Focuser

Economical in size and price. All metal construction. Top surface mirror. Hairline suspended reticle caps. Ideal for students and beginner darkroom technicians.

EMS033 10 X Mini-Sight Focuser

samigon® Focus-Scope for Enlarging

Helps enable pinpoint focusing for enlargements. Solid all-metal construction. Adjustable focussing eyepiece and crosshatch target allows for individual accuracy. Grain focusing by aerial image principle. Attractive self-selling box.

ESA071 Enlarging Focus Scope



Marumi Enlarging Lenses

Top quality enlarging lenses with coated and color corrected optical glass elements. Iris diaphragm has click stops. All lenses have 39mm (Leica) mounting thread to fit standard lens board.



ESA102 50mm, f/3.5-f/16, for 35mm format
 ESA103 75mm, f/3.5-f/16, for 6 x 6cm format
 ESA105 105mm, f/4.5-f/22, for 6 x 9cm format
 ESA106 135mm, f/5.6-f/22, for 4 x 5 format

PERSONAL SERVICE IS OUR #1 PRIORITY



East: 111 Asia Place, Carlstadt, NJ 07072 (201) 939-7722
 West: 4055 W. Shaw Ave. #105, Fresno, CA 93722 (559) 277-3572

FAX: (201) 939-7782
 FAX: (559) 277-3574

E-8

Enlarging Accessories

CPM/Delta VariSharp Enlarger Alignment Tool

Allows proper alignment of enlarger. Adjustable tubular spirit level reads increments of pitch/slope within 30 arc minutes (1/2 of one degree). Converts into a precision 12" level by locking the thumb wheels. Made of acrylic.

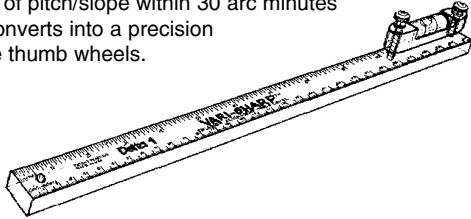

ECP313410 Vari-Sharp 13410

CPM/Delta Projection Print Calculator Scale

Gives perfect exposures every time. Eight pie wedges of calibrated graduated density tell you the right number of seconds after one test exposure. Saves paper and chemistry. Easy to use. 4" x 5".

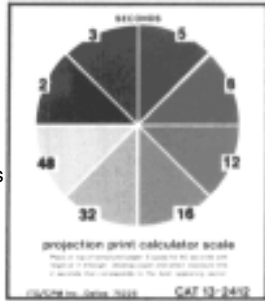

ECP230 Projection Print Scale 12610

CPM/Delta 2 in 1 Cropper

Crops 5 x 7 and 8 x 10 negatives, transparencies, and prints. Black reverse for transparencies, black border viewing. Quick accurate composition in inches and centimeters.

PRO-C: 8 1/2" x 11", 4" x 5" opening
PRO-A: 5" x 8 1/2", 2" x 3" opening

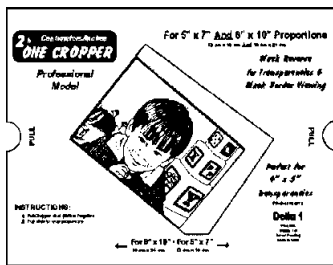

ECP232 PRO-C 2-in-1 Cropper 22110

Testrite Dodging Kit

Made of heavy-duty red plastic material. Rustproof plated wire and handle. Ideal for dodging work while enlarging. Complete instructions included.



ETE001 Dodging Kit DG

TINTYPE PARLOR

Consists of (5) 4 x 5 metal plates, that you can cut to fit inside your camera, plus photosensitive emulsion and a special developer to make the "instant" photographs of the last century.

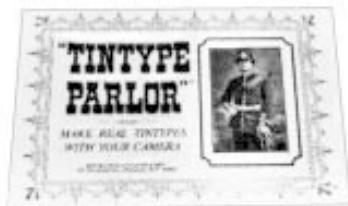

ERL255 Tintype Parlor Kit

Testrite Vignetter, V-1

Made of heavy-duty red plastic material on stiff cardboard. Unit can be used with or without serrated edges for any desired effect and leaves are adjustable for size of opening. Complete instructions included.

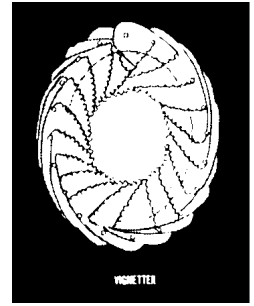

ETE010 Vignetter V-1

Testrite Vignetter Wheel, V-2

Rigid plastic back and wheel has seven different size and shape openings for vignetting. Useful for all Black & White and Color enlarging.

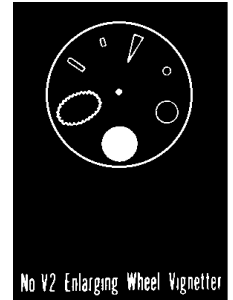

ETE012 Vignetter Wheel V-2

Testrite Vignetter, V-3

Made of heavy gauge black plastic with 8 pre-cut 4 x 5 inserts for blocking out background while creating a design around the subject. Complete instructions included.



ETE013 Vignetter V-3

CPM/Delta Bes-Board

4 x 4 recessed lens board. 39mm/Leica mount hole. Fits 99% of all enlarging lenses.

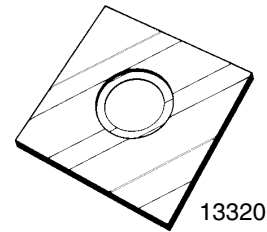

ECP312010 Bes-Board 13320

CPM/Delta Bes-Align

Calibrates lens with enlarger. Adjusts front to back and left to right with three control knobs. Test negative included for lens fall-off, lens distortion, edge-sharpness and parallel alignment. Lens board 4" x 4".

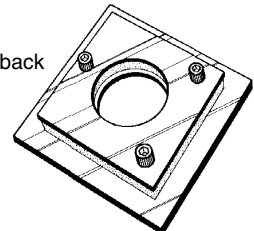

ECP312000 Bes-Align 13310

FOR FAST DELIVERY CALL TOLL FREE!

EAST
1-888-ARGRAPH
OR 1-800-526-6290

WEST
1-888-WESTARG
OR 1-800-323-9069

samigon® 4-in-1 Easel

All metal easel with pre-masked sizes to accept most popular papers.

Holds papers cut to the following sizes: 2¼" x 3¼", 3½" x 5", 5" x 7", and 8" x 10".

Even margins are assured.

Unit is easy to use and paper can be inserted quickly. Rubber feet on both sides prevent slipping.

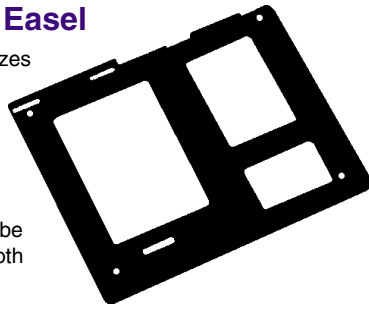

ESA004 4-in-1 Easel

CPM/DELTA Magnetic Enlarging Easel, 11 x 14

Precise and durable. Magnetic "Cone of Light" angle bars for precise, borderless settings. Black matte finish. Cork non-skid base.

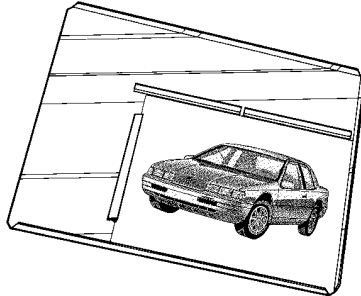

ECP244 Magnetic Enlarging Easel, 11 x 14 13810

Sylvania or G.E. Enlarging Lamps

We reserve the right to substitute G.E. lamps for Sylvania or vice versa. Listed are the most popular lamps. Other lamps available on special order. Write for lamp catalog. (See price book for costs).

Argraph Item#	ANSI	Watts	Volts
DL/111A	111A	75	125
DL/140	140	75	120
DL/212	212	150	115-125
DL/213	PH213	250	115-125



Safety First Lever Cutters

Quality and safety characterize these lever action paper cutters. Trims up to 10 sheets of paper quickly and easily.

Lightweight, but sturdy, polyboard resin base with guidelines for trimming a variety of formats.

Upper and lower blades made from Solingen steel for a precise cut every time.

Patented design prevents upper blade from flying up or dropping down.

Transparent fan and finger guard holds paper securely during cut while protecting fingers. Integrated scale bar and an adjustable backstop for accurate trimming.



EDL403 Safety First Lever Cutter - 12" 403
EDL404 Safety First Lever Cutter - 18" 404

Cut-Cat Rolling Trimmers

Lightweight, compact and safe. Self-sharpening rotary blade enclosed in a housing so it is only exposed to the cutting edge. Transparent clamp and work surface ruled in inches. Quick reference marks for proper alignment of material. Rubber pads for stability.

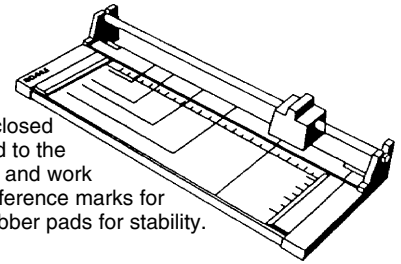

EDL507 12½" cutting length 507
EDL508 18" cutting length 508
EDL500R Replacement Blade Assembly for 507/508 RBAC

Heavy Duty Rolling Trimmer

For precision cutting of light to medium weight material. Ideal for laminate, film, acetate, poster board, blueprint paper, etc. Cuts up to 10 sheets of 20lb. paper. Safe rotary blade shielded by tough plastic housing. Accurate inch and metric ruler with backstop. Heavy duty glide bar. Table area calibrated in centimeter squares on models 550, 552, and 554. Lifetime Guarantee. Optional roll attachment available.

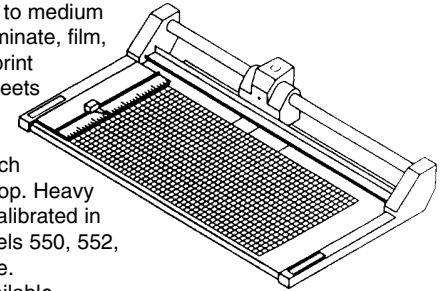

EDL550 13¾" cutting length 550
EDL552 18⅛" cutting length 552
EDL554 26⅜" cutting length 554
EDL556 37½" cutting length 556
EDL558 50" cutting length 558

All-Metal Lever Cutter

Precision made with patented Dahle safety guard which prevents the cutting of anything, except paper properly inserted underneath the clamping bar. Metric and US scales. Adjustable back stops and safety guard on both models.

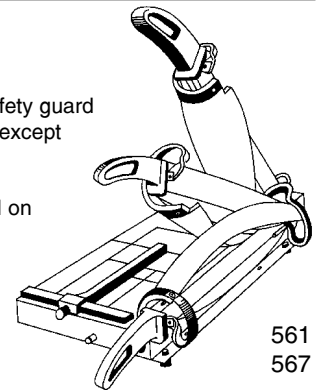

EDL561 14½" cutting length 561
EDL567 21½" cutting length 567

VANTAGE Trimmers

- Locking, spring-action metal blade
- Automatic clamp guards fingers and ensures accurate trimming
- Clear grid with inch and metric scales
- Metal base won't warp, shrink or crack
- Non-skid rubber feet
- Limited lifetime warranty



EDL12E 12" Trimmer 12E
EDL15E 15" Trimmer 15E
EDL18E 18" Trimmer 18E

PERSONAL SERVICE IS OUR #1 PRIORITY



East: 111 Asia Place, Carlstadt, NJ 07072 (201) 939-7722
West: 4055 W. Shaw Ave.#105, Fresno, CA 93722 (559) 277-3572

FAX: (201) 939-7782
FAX: (559) 277-3574

E-10 Paper Trimmers/Cutting Mats

FISKARS®

Paper Trimmers

Perfect for trimming photos and creating a decorative scrapbook. Both inch and metric scales are printed on clear rails. Each blade carriage is durable enough to make over 1,000 cuts. The 8½" Personal Trimmer has built-in holes to enable it to be stored in most standard ring binders including 3, 5, and 7-ring binders as well as A4 size binders. Packed 6 per box.

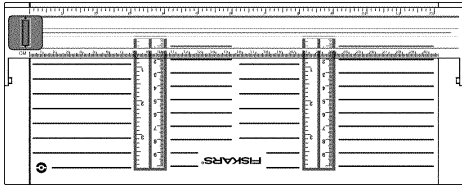

HFI2638	8½" Personal Paper Trimmer	2638-7097
HFI9605	8½" Personal Paper Trimmer (Blue)	9605-7097
HFI9598	12" Paper Trimmer	9598-7097

Replacement Blades:

HFI2639	For 8½" and 12" Trimmers, Pk/2	9596-7097
---------	--------------------------------	-----------

FISKARS®

Rotary Trimmers

Rolling blade stays close to the cutting surface for accurate and safer cutting. 4-sided cutting strip improves cutting performance and prolongs blade life. Pivoting carriage guide for easy loading and securing of paper — prevents fanning or shifting. Accepts interchangeable decorative and speciality blades.

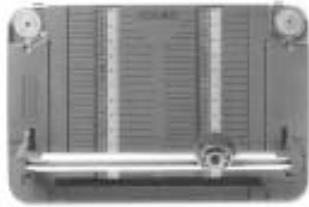

HFI9580	12" Rotary Paper Trimmer
HFI9583	24" Rotary Paper Trimmer

Decorative Blades:

HFI9532	45mm Pinking Rotary Trimmer Blade
HFI9533	45mm Wave Rotary Trimmer Blade

Kindermann Lever Trimmer

Six inch cutting length. Stainless steel straight cutting blade. Baseboard made of rigid Dukalit ABS plastic. Ideal for trimming passport photos and similar size photographs. Complete with transparent pressure ruler with border width indicator and guide strip with scale.



EKM7220	6" lever trimmer	7220
---------	------------------	------

DAHLE

"KNIFE MAT" Cutting Mats

Triple layered construction. Self closing cutting surface, blade resistant core. Printed guide lines.

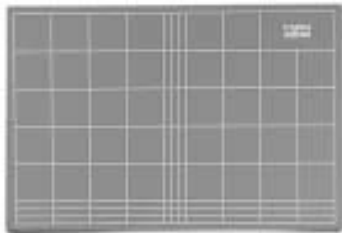

EDL690	8¼ x 12" Knife Mat Cutting Mat	10690
EDL691	12 x 18" Knife Mat Cutting Mat	10691
EDL692	18 x 24" Knife Mat Cutting Mat	10692
EDL693	24 x 36" Knife Mat Cutting Mat	10693

DAHLE

Heavy Duty Cutters

The Dahle items listed below will be drop shipped from the factory. Freight Prepaid.

Special Purpose Cutters

Heavy duty unit designed for cutting poster board, mat board, and foam core. Perfect for the framing industry.

- Patented, beveled blade of Solingen steel
- Self-adjusting clamp holds materials securely and prevents slipping
- Fan guard protects fingers
- Lockable T-square for accurate measurements and precision 90° cuts
- Measurements in inches and millimeters
- Cuts up to 20 sheets

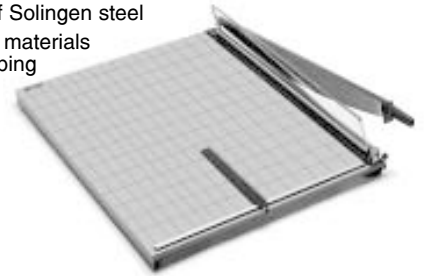

EDL130	30" Paper Cutter	130
EDL136	36" Paper Cutter	136
EDL142	42" Paper Cutter	142

Heavy Duty Ream Cutter

For quick and accurate cutting of large paper stacks.

- Ground upper blade
- Safety cover
- Quick-action clamp
- Scale bar imprinted in inches and centimeters
- Adjustable back-stop
- Cuts up to 200 sheets
- Optional floor stand available



EDL842	HD Ream Cutter - 17"	842
--------	----------------------	-----

Heavy Duty Cutter

Millimeter accuracy guaranteed by a spindle-driven backstop.

- Ground upper blade
- Safety cover
- Quick-action clamp
- Scale bar imprinted in inches and centimeters
- Spindle-driven, self-locking back-stop
- Optional floor stand available



EDL846	HD Cutter - 17", cuts 500 sheets	846
EDL848	HD Cutter - 18½" cuts 700 sheets	848

FOR FAST DELIVERY CALL TOLL FREE!

EAST
1-888-ARGRAPH
OR 1-800-526-6290

WEST
1-888-WESTARG
OR 1-800-323-9069

CPM/Delta Electrostatic Film Drying Cabinet

Dries film with controlled and filtered warm air in a dust free environment. cleans and removes 97% of airborne particles with a patented, permanent, self-charging electrostatic air filter element.

Standard Features:

- Adjustable heat and timer controls
- Safety thermostat and power switch
- Heavy duty fan
- Stainless steel bottom drip pan
- 2 film clip bars with 20 clips (additional clips are available)
- ProtectAir prefilter which removes larger particles

Holds up to:

80 rolls 36 exposure 35mm film

45 rolls 120mm film

(optional drying rack available for larger sizes)

Specifications:

Outside Dimensions: 23" x 22" x 78"

Inside Dimensions: 21½" x 20" x 65"

Weight: 125 lbs.

115V, 60Hz, 15 Amp



GCP230010 Electrostatic Film Drying Cabinet 58010

Blotter Books

For drying color or black & white RC prints. Lintless, chemically pure blotters absorb moisture. Prints dry flat.

CPM/Delta Blotter Books

ECP223 8 x 12 (120lb. paper) 13010

ECP225 12 x 15 (120lb. paper) 13020

ECP227 19 x 24 (120lb. paper) 13030



samigon® Bamboo Print Tongs

Made of the finest quality bamboo. Tongs are 9" long and have non-slip, non-scratch rubber tips to hold photo paper.

Pack of 3 tongs for pegboard display. Sold only in box of 10 pegboard packs of 3 tongs (total of 30 tongs).



ESA221 Box/10, (pk/3 set) Bamboo Print Tongs

Testrite Print Rollers

Individually carded for pegboard and slatwall displays.

20 Series

A lightweight roller with fine, smooth action to efficiently remove surplus water from prints and distribute an even pressure.

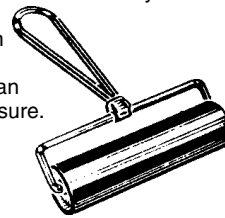

ETE524	4" print roller	24B
ETE526	6" print roller	26B
ETE528	8" print roller	28B

Heavy Duty Print Roller

Sturdy, smooth action rollers made of the finest quality ground rubber tubing. Roller rides on steel ball bearings, insuring long life and even pressure.

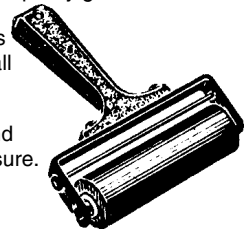

ETE564	4" heavy duty roller	64B
ETE566	6" heavy duty roller	66B
ETE568	8" heavy duty roller	68B

Lucite Print Roller

Lucite type cast acrylic rollers. Use with gluing machines. Will not pick up rubber cement or wax.

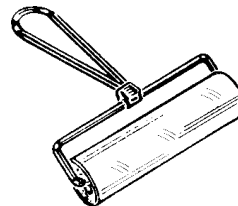

ETE574	4" lucite roller	44LB
ETE576	6" lucite roller	46LB

Soft Rubber Print Roller

Specially formulated soft rubber 1 1/8" diameter. Designed for special applications.

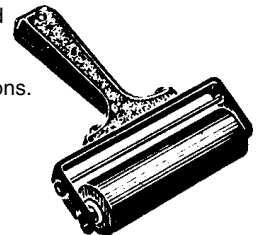

ETE580	6" soft rubber roller	76B
ETE581	8" soft rubber roller	78B

samigon® Print Trays

"You'll recognize the quality immediately!"

- Strong, durable, chemical-resistant construction
- Base ribbing ensures rigidity, prevents prints from sticking to tray
- Thermometer rests keep thermometer from sliding into solution
- Extra large pouring spout reduces chemical splash
- Sets include one each of tan, red, and green, for quick identification of solution.



	Print Size	Dimensions		Ctn Qty
		Inner	Outer	
ESA521	8 x 10	8½ x 10½	2¼ • 10¼ x 12¼ x 2½	24
ESA531	12 x 16	12¾ x 17½	3 ⅜ • 15 x 19½ x 3¼	12
ESA541	16 x 20	16½ x 20½	3 ⅜ • 18¼ x 22¼ x 3¼	12
ESA505	Set of 3, 5 x 7	5½ x 7½	2 • 7 ⅞ x 9 ⅞ x 2½	26
ESA508	Set of 3, 8 x 10	8½ x 10½	2¼ • 10¼ x 12¼ x 2½	8
ESA512	Set of 3, 12 x 16	12¾ x 17½	2¼ • 15 x 19½ x 3¼	4

Pfaff Standard Developing Trays

White, lightweight, ribbed bottom standard trays have a pouring lip and easy lifting rim.

Acid and stain resistant.

EPF508	Standard tray, 8 x 10	ST-810
EPF512	Standard tray, 16 x 20	ST-1620



PERSONAL SERVICE IS OUR #1 PRIORITY



East: 111 Asia Place, Carlstadt, NJ 07072

(201) 939-7722

FAX: (201) 939-7782

West: 4055 W. Shaw Ave. #105, Fresno, CA 93722

(559) 277-3572

FAX: (559) 277-3574

REXTON

Anti-Static Ultra-Efficient Film Cleaner

Cleans both prints & all films. Removes grease, skin oils, marking pencils, masking tapes, and adhesives.

- ERX001 Cs/12, 4oz. pump spray
- ERX016 Cs/6, 16oz. applicator container
- ERX032 Cs/6, 32oz. applicator container
- ERX128 1 Gallon (4 quart) pack



Lens and Optical Surface Cleaner

Cleans oils, grease and dust from coated and non-coated lenses. With ordinary lens paper, it lifts and dissolves all surface contaminants, carrying them away from the lens surface, leaving no residue.

- Contains no detergents, ammonia or alcohol!
- Neutral in pH!
- Indefinite shelf life.
- Does not attack plastics and painted surfaces.
- Also cleans camera parts that are soiled during normal use!

- ERX004 Cs/12, 1oz. applicator container
- ERX009 Cs/12, 8oz. pump spray

Printhead Cleaner/Declogger

For large and small format inkjet printheads. Helps to maintain inkjet print image integrity.

- ERX505 Cs/4, 4oz. Cleaner/Declogger

Photochemical Stain Remover

Removes chemical stains from your clothes.

- ERX024 Cs/6, 2oz. applicator container

Hyper-Wet 240 Wetting Agent

Diluted 240:1 it makes water roll off the film streak free. The harder the water, the better it works. No need to wipe off film after use. Just dip the film in and hang up to dry.

- ERX551 Cs/12, 4oz. ctn (makes 7 1/2 gal)
- ERX552 Cs/6, 16oz. ctn (makes 30 gal)



Fix-A-Sure

A hypo tester for exhaustion. Tests both B&W and color fixers.

- ERX509 Cs/6, 2oz. applicator container

Hi-Quanta Luminous Paint (non-toxic)

Yellow-green or orange paint marks items so you can quickly find them in the dark. Glow from paint will not fog color or B&W film.

- ERX572 2oz. container



Flash-Dry Rapid Film Dryer

32oz. container

- ERX379 Flash-Dry Rapid Film Dryer

Proof or Preview RC Print

Rubber Stamping Kit

- ERX465 RC Print Rubber Stamping Kit

Scratch-Match

Comparable to Edwal No-Scratch.

Includes 2 brushes (film base scratch maskant for enlarging)

- ERX522 Cs/12, Scratch-Match, 1oz.

Print Flattening Agent

- ERX529 Cs/6, Print Flattening Agent, 16oz.

CPM/DELTA

CPM/Delta C-100 Total Emulsion Cleaner

Cleans film and print surfaces of most permanent ink, ball-point ink, oil, grease, adhesive, fungus, smoke, and color developer tar. Evaporates on contact. Safe for all silver based films, transparencies and papers. Metered pump top. Not intended for gelatin or non-hardened surfaces.

- GCP244020 Display/6, C-100, 4 oz. pump 25330

CPM/Delta Film Cleaner

Cleans all black & white and color negatives and positives. Removes grease, oils, adhesives, dust and dirt. Contains no water. Will not swell emulsion. Safe, clean and effective. Available in a 6oz. pump.

- GCP244040 Display/12, Film Cleaner 25351

FA-1 Fabric Sensitizer

Intended for wearing apparel such as T-shirts. Does not stiffen fabric. Requires contact-printing with a full-sized negative. Can also be coated on paper to make cyanotypes and VanDyke brownprints.



- ERL211 Fabric Sensitizer, 32oz.

FA-1

LIQUID LIGHT Emulsion

A liquid photo emulsion that allows you to make black and white photo prints on virtually any material. Sensitize virtually any material – cloth, metal, paper, plastic, rock, chinaware, glass, canvas, even an egg – then process quickly and easily with just your enlarger, standard paper developer and fixer. No fumes or odors. No toxic chemicals.

- ERL203 Liquid Light Emulsion, 8 oz.
- ERL205 Liquid Light Emulsion, 16 oz.
- ERL207 Liquid Light Emulsion, 32 oz.

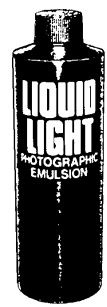

AG-PLUS Emulsion

Resembles Liquid Light but is designed for transparent surfaces like clear glass because it contains a higher solids content for extra density. Handling and processing are the same as with Liquid Light.

- ERL213 Ag-Plus Emulsion, 8oz.



PRINTINT Colorants

Contains the 3 primary colors, for use with Liquid Light prints or photographic papers. It produces a colored background without altering the black image, an effect similar to a black-and-white print on colored paper. Printint can also be brushed onto a portion of the print, or used to retouch color prints. Colors can be mixed for intermediate hues.

- ERL225 Printint Dyes



FOR FAST DELIVERY CALL TOLL FREE!

EAST
1-888-ARGRAPH
OR 1-800-526-6290

WEST
1-888-WESTARG
OR 1-800-323-9069

PolyToner

Rockland Colloid's Polytoner contains bleach, so it can be used for after-processing as well as color-developing.

Unlike single-color toners, Polytoner can tone prints any color you desire. Polytoner uses true color-coupling chemistry: It tones the black image to color without affecting the background highlights.

(Effect: A black tree against a white sky is toned with Polytoner green. The sky stays white, the tree becomes green.) Polytoner can be used with all black & white photographic papers and with Liquid Light prints.

The package contains red, yellow and blue color couplers together in dropper bottles so that colors can be blended together to tone prints any color or combination of colors.



ERL223 Polytoner

SelectaColor Liquid Printing System

SelectaColor is a process for producing brilliant multicolor prints on paper, plastics, glass, ceramics, metal, and other materials. Use it to make continuous-tone prints of any size.

The procedure can be handled entirely under room light:

- Apply a selected pigment by brush, spray, roller, cloth or sponge. (Kit includes blue, red, yellow and black. Other colors are available.)
- Print onto the surface through a negative transparency.
- After exposure, wipe off excess pigment with a damp sponge. The areas that have been hardened by light will remain intact, while the unexposed areas will dissolve, revealing a brilliantly colored positive image.

Colors can be mixed together for intermediate hues or applied in sequence for multicolored prints. SelectaColor prints are permanent, as they consist of solid pigments, not fugitive dyes. Cleanup is easy with cold water.

Originally designed as a "quick-proof" method for making pre-press color proofs, SelectaColor is a valuable resource for commercial printers and one-of-a-kind fine-art printmakers alike.

ERL229 Selectacolor Kit

Individual colors are available in quart and gallon sizes.



HALO-CHROME Silver Toner

For all photographic papers. It converts a conventional photographic print to a metallic mirror image, by fusing together the black colloidal silver particles to form a solid silver image. You can use Halo-Chrome three way to make a black on silver print, a silver on white print, or a silver on color print with PRINTINT.

ERL227 Halo-Chrome Silver Toner



Kindermann Tank Lid Filter Funnel

Made to fit top of tank with lid off. Mesh screen filters chemicals. Made of high impact plastic, rigid, black color. 2" high.

EKM171 Tank Lid Filter Funnel



23171

samigon® Graduates

Impact resistant clear plastic. Can withstand temperatures to 212°F/100°C. Large markings in both ounces and cc's. Large base for excellent stability.



	Contents	Height	Diameter
ESA451	2 oz. (50cc)	4¾"	1"
ESA452	3¾ oz. (100cc)	4½"	1⅞"
ESA453	11 oz. (300cc)	7"	2"
ESA454	21 oz. (600cc)	8"	2⅝"
ESA455	36 oz. (1000cc)	10"	3"

CPM/Delta Mix-Up Cups

Shatterproof polypropylene cups with graduates marked in oz. and cm. with pouring lip. Available: Set of 10, assorted 1 oz. - 22 oz. (30ml to 600ml) and display of 10, 22 oz. (600ml) graduates.

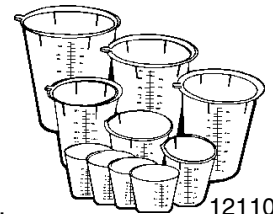

ECP336	Set/10, asst. 1oz. - 22oz.	12110
ECP360	Disp/10, 22oz. Mix-up cups	12125

samigon® Air Evacuation Bottles

Opaque plastic accordion bottles for light-and-air sensitive photographic solutions.

The accordion system allows the bottle side to be adjusted to the level of the contents thereby reducing oxidation.



ESA432	1 Liter Air Evacuation Bottle
ESA433	2 Liter Air Evacuation Bottle

CPM/Delta Chemical Containers

All bottles are high density, brown polyethylene. They are infrared sterilized, silk screened in epoxy ink and have Polydome™ linerless closures. Must be ordered in full carton quantities indicated below.



Datatainer

ECP112	Print (master/24)	11150
ECP116	1/2 gallon (master/12)	11170
ECP118	Gallon (master/10)	11180

Datatainer with Liquid Level

ECP114	Quart (master/24)	11160
ECP114D	Quart (Drop Ship- multiples of 100)	11120

CPM/Delta Spill Proof Filter Funnel

Made of heavy duty, lab grade polypropylene. Features a removable Spill Ring, 2" filter, and 18" extension. 40oz.

ECP022000 Spill Proof Filter Funnel

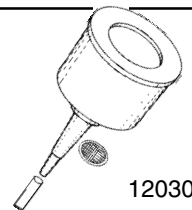

12030

PERSONAL SERVICE IS OUR #1 PRIORITY

E-14 Thermometers/Black Out Cloth/Safelights

Testrite Straight Thermometers

Model 929

Tank and tray glass. Floats upright or in tray. Has rubber washer around glass to keep unit face up. 6½" long.



ETE929 Bx/12, Thermometer 929

samigon® Dial Thermometer

Made of corrosion resistant stainless steel. Fits tank, tray or mixing vessel. Has clamp to attach to tray. 1¼" dial face (2⅛" bezel to bezel) with accurate needle is easy to read with markings of 1° gradations. Reads both °F and °C. Accurate within 1°. 5" stainless steel stem fits all developing tanks. Hermetically sealed, fog and leak proof. 25° to 125° F or -5° to 50° C readings. Can be calibrated for greatest accuracy. Blister packed. Made in USA. Master: 10.



ESA920 Dial Thermometer

samigon® Digital Electronic Thermometer

- 3 second update
- Never needs calibration
- 0.33"/9mm LCD display
- 5" Stainless steel probe
- Head tilts 30°, 60° and 90°
- Range: -50° C to 150° C, 25° F to 125° F
- Battery included (1 year life) (A76 or equiv)
- Blister packed. Master: 20.



ESA925 Digital Thermometer

CPM/Delta Glass Thermometer

Crystal clear, hermetically sealed, 6" darkroom thermometer for developing tank or tray. Calibrations are in Fahrenheit and Centigrade in 2° increments. Specifically marked and calibrated at 68° by a triangle with a total range from -20°F to 120°F for all color/black and white developing and printing. Display card/10.

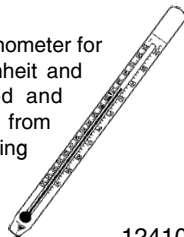

ECP364 Cd/10, Glass Thermometers 12410

CPM/Delta Black Out™ Cloth

Heavy opaque 6 mil plastic cloth with triple carbon black seals out light. Ideal for windows and doors. Use again and again. Available in two sizes: 2ft. x 16ft. & 4ft. x 16ft.

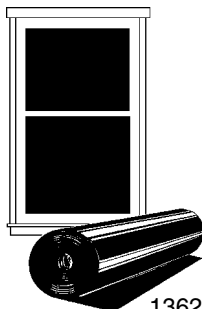

ECP380 Black Out Cloth, 2ft. x 16ft. 13620
ECP382 Black Out Cloth, 4ft. x 16ft. 13630

Testrite Deluxe Safelight

Heavy duty. Includes 5½" OC filter. Complete with socket, cord, on/off switch. Bracket permits unit to swivel in all directions. Base can be fastened to wall or ceiling or will stand on table. UL listed. Uses 15W bulb. **Bulb not included.**

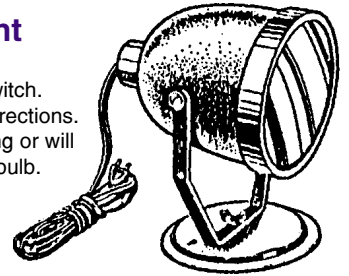

ETE901 5½" Safelight w/OC filter 5 1/2F

Testrite 5½" OC Filter Only

5½" diameter OC type filter. Individually packed.

ETE955 5½" OC Filter Only OC 5 1/2

Testrite Economy Safelights

MODEL 3A: Complete with socket, cord and on-off switch. Aluminum bracket permits unit to be swiveled in any direction. Base can be fastened into wall or ceiling or unit will stand by itself on table. Metal body and front filter ring. UL listed. Filter included- suitable for all multi-contrast and normal enlarging papers. **Bulb not included.**

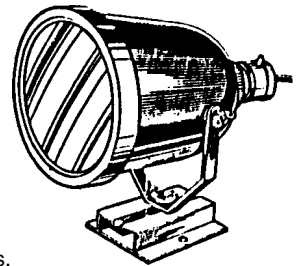

MODEL 3B: Same as above but without stand socket and cord. Has male thread to screw into bulb socket.

ETE921 Model 3A economy safelight 3A
ETE923 Model 3B economy safelight 3B

CPM/Delta BriteLab Safelight Lamps

25W jumbo safelights given more light-360° dispersion. Available in Red (ortho film), Amber- for enlarging paper.

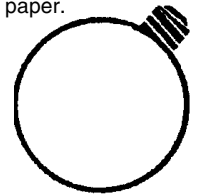

ECP255 Universal, red for film (ortho) 35010
ECP257 OC- Amber for paper 35020

CPM/Delta BriteLab Junior Safelight

Screws into light fixture. 11 watt, in red only. Adequate for small darkroom.



ECP259 Junior Safelight- universal, red 35110

FOR FAST DELIVERY CALL TOLL FREE!

EAST
1-888-ARGRAPH
OR 1-800-526-6290

WEST
1-888-WESTARG
OR 1-800-323-9069

BANDUST® Compressed-Gas Dusters 100% Ozone Safe Ultra Filtered Moisture-Free

The safe, easy way to blow away dust and dirt. Ideal for: Cameras, Computers, Electronics, Darkroom and much more.



- ERG101 Case/12, 10oz with Disposable Nozzle
- ERG123 Case/12, 3½oz with Disposable Nozzle
- ERG135 Case/12, 10oz Refill

BANDUST® Micro-Fiber Cleaning Cloths

Anti-Static • Certified Clean Room Quality
100% Lint-free, Scratch-free • No Chemicals
Machine Washable and Reusable

Safely wipes away dirt, oil, fingerprints, and smudges. Ideal for lenses, filters, computers, CDs, DVDs, jewelry, crystal, scientific instruments, etc.



- GRG913 Box/24, 9" x 9" Micro-Fiber Cloths

BANDUST® Chrome Nozzle for Refills

Fits all standard refill cans.

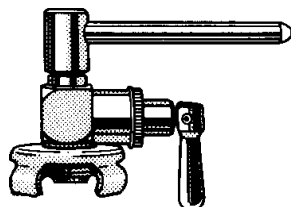

- ERG326 3½" Nozzle

Pro-Co DUST-STAT RM-2 PLUS Airless Film Cleaner

Extremely compact. Designed for mini-printers where space is at a premium—takes up only 1½" x 4" and is completely safe with micro processor control systems. A unique method of manufacture incorporates a row of highly efficient ionizing points, which eliminate static from the film passed through the cleaner. Because of new methods of charging these points, only one set is necessary. The RM-2 Plus is also fitted with a pair of ultra-soft, man-made fibre brushes, which can be slid into molded channels for left hand or right hand use. The brushes remove any debris from film surfaces and can easily be removed for cleaning.



- EDS129 RM-2 Plus Film Cleaner with #119 Power Module 129
- EDS119 Dust-Stat MK4 Power Module only w/2 outlets, 110-120 119
- EDS160 Ionizing Air Nozzle 160

Kimwipes

Disposable wipers by Kimberly Clark. Fine crepe surface is super absorbent, strong and nonabrasive.

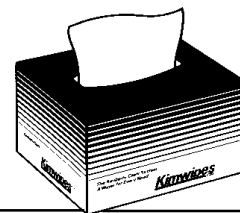

- EKW341 Bx/280, 4½ x 8½
- EKW342 Bx/140, 15 x 17

Staticmaster Brushes and Accessories

Creates a clean, static-free surface area by utilizing its highly efficient polonium source located in the cartridge. The polonium neutralizes static electricity. Then the fine textured, soft tipped Staticmaster brush clears the neutralized area of any accumulated dust, lint, and other foreign particles. The cleaned surface area will remain static-free and will not re-attract dust, lint and other particles until it is recharged by rubbing or handling. Two sizes available: 1" model ideal for use in 35mm photography.



It was designed to clean negatives, slides and lenses. 3" model designed to clean large surface areas. It features a retractable brush. A 6 x 9 inch unit can be assembled by using easy-to-install connectors.

- ENU911 Brush, 1" 1C200
- ENU913 Replacement Cartridge, 1"
- ENU935 Brush, 3" 3C500
- ENU937 Replacement Cartridge, 3"
- ENU939 Connectors for joining 3" model (1 required to join 2 brushes- 2 required to join 3 brushes)

Pro-Co STATVAX 2000 Anti-Static Cleaner

A low cost anti-static film cleaner, with vacuum effect, for up to 70mm film. Dissipation of static is achieved using brushes manufactured from a unique, conductive, man-made fiber which is mixed with natural hair.

A high velocity fan creates a vacuum effect between the brushes. This vacuum removes dust particles from both the top and bottom of the film as it passes through the channel between the brushes. The dust is removed onto a special Electret filter. Filters are disposable and can be changed in seconds.

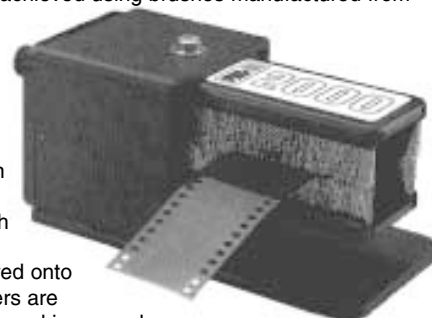

Operates on a safe 12V DC adapter (included for 110V use) and is also available as special order for use on 200-240V.

The lightweight construction of the STATVAX 2000 makes it ideal for installation on carriers or some moving stages. The cleaner can be either permanently fixed or secured with the velcro supplied.

Under certain circumstances, such as near zero humidity, where the performance of the STATVAX 2000 could be impaired we allow provisions for an earth/grounding strap to ensure maximum efficiency.

- EDS171 STATVAX 2000 Anti-static Cleaner 171
- EDS451 PK/10, Replacement filters 150FILT
- EDS472 PK/2, Replacement brushes 172BRUSH (order 2 pairs for complete replacement)

PERSONAL SERVICE IS OUR #1 PRIORITY



East: 111 Asia Place, Carlstadt, NJ 07072

(201) 939-7722

FAX: (201) 939-7782

West: 4055 W. Shaw Ave. #105, Fresno, CA 93722

(559) 277-3572

FAX: (559) 277-3574

ABS Sinks: These super tough sinks take everything you can give them and more. Compact, one piece construction fits where others can't. Ribbed bottom for rapid draining and complete water circulation. Thermoformed from black 1/4" ABS. 10 year limited warranty.

Stands: Heavy 1000 lb. test steel structure stands. Epoxy painted surface resists chemicals and rust. Assemble in 5 minutes with a screwdriver. All stands are equipped with self-leveling, adjustable legs that adjust vertically to eliminate wobble due to uneven floors. 10 year limited warranty.

The One Hour Sink™

Designed for rack cleaning and deep tank usage.

Extra thick 1/3" ABS.
Holds three 11 x 14 trays.
Requires two ABS drain sets.
Ships Truck.



ECP419D	Sink only, 72" x 29" x 10"	62730
ECP088872	HD Stand only, 72" x 28" x 36"	62795
ECP408D	One Hour Sink Package (Includes: ABS Sink, Stand, Installation Pac II)	62740

The SINK II

Our most useful sink. It has a 13" backsplash and side splash guards. The 6 ft. sink holds four 16 x 20 trays.

The 4 ft. sink is perfect for small labs. It holds four 11 x 14 trays or two 16 x 20 trays.



ECP087525	The Sink II, 48" x 33" x 13", 6" Deep (UPS)	62470
ECP088530	HD Stand II, 48" x 33" x 36"	62495
ECP088539	ABS Shelf for ECP088530 stand	62497
ECP087517	The Sink II, 72" x 33" x 13", 6" Deep	64720
ECP088520	HD Stand II, 72" x 33" x 36"	64750
ECP088529	ABS Shelf for ECP088520 stand	64759

TRP The Sink™ II

"Temperature Regulated Processing".

State of the art, fully assembled, plumbed, and lab tested.

FEATURES:

- ± 1/2°F
- 1-7 GMP Mixer
- Check stop valves
- Vacuum breaker
- Dual scale 3" thermometer w/recalibration screw
- 4 ft. armored spray hose
- Thermostatic mixer manual
- 3 valves tempered and 1 untempered water outlet with 3/4" GHT fittings
- 100% chromed brass fittings and stainless steel armored 1000 lb. test tubing.



ECP087527	TRP The Sink II, 48" x 33" x 13", 6" Deep (UPS)	62450
ECP088530	HD Stand II, 48" x 33" x 36"	62495
ECP088539	ABS Shelf for ECP088530 stand	62497
ECP087515	TRP The Sink II, 72" x 33" x 13", 6" Deep	64710
ECP088520	HD Stand II, 72" x 33" x 36"	64750
ECP088529	ABS Shelf for ECP088520 stand	64759
ECP087511	Hot & Cold Water Filter Set (Includes: Hot & Cold Filter Housings, Filters, Stainless Steel Brackets, Shutoff Valves, and Connectors)	70010

This is only a partial listing of CPM/Delta Products. For a complete listing, request a CPM/Delta catalog. The entire line of CPM/Delta Products is available through Argraph.

FOR FAST DELIVERY CALL TOLL FREE!

EAST
1-888-ARGGRAPH
OR 1-800-526-6290

WEST
1-888-WESTARG
OR 1-800-323-9069

Washing Well II Sink

Two sinks in one with an overflow channel between. Excellent for temperature controlled water baths or washing. Holds four 11 x 14 or three 16 x 20 trays. Requires two ABS drain sets. Black. Ships by truck.

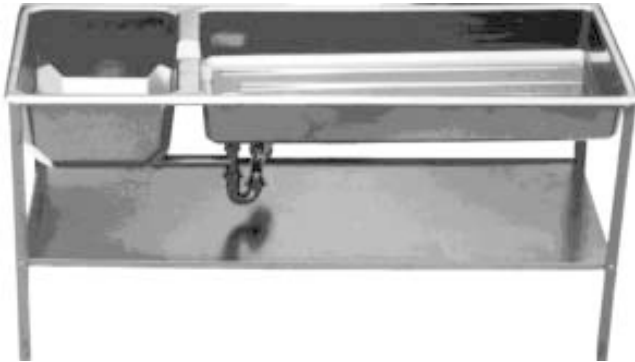

ECP087207 W.W. II Sink, 72" x 28" x 7" & 11" 62760
 ECP088872 HD Stand only, 72" x 28" x 36" 62795

6 ft. Econo TRP Sink

1-7GPM Mixer. 3" thermometer with recalibration screw. One valve tempered, one untempered water outlet with 3/4" GHT fitting. Holds three 16 x 20 trays. Ships by truck.



ECP082870 Sink only, 72" x 29" x 5" 62720
 ECP088872 HD Stand only, 72" x 28" x 36" 62795

4 ft. Econo Sink

Our most economical sink. Ribbed draining at one end. Holds three 11 x 14 or two 16 x 20 trays. Black. Ships UPS.



ECP404D Sink only, 48" x 24" x 5" 62430
 ECP088448 HD Stand only, 48" x 24" x 36" 62445

6 ft. Econo Sink

Holds three 16 x 20 trays. Black. Ships truck.

ECP087206 Sink only, 72" x 29" x 5" 62750
 ECP088872 HD Stand only, 72" x 28" x 36" 62795

8 ft. Commercial Sink

For the working lab. Holds six 11 x 14 or four 16 x 20 trays. Black. Ships by truck.

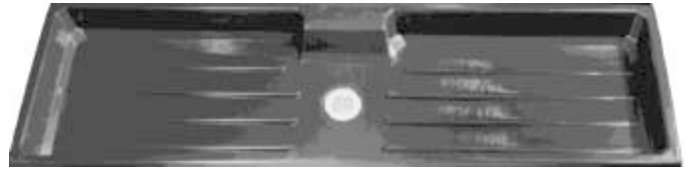

ECP417D 8 ft. Sink only, 96" x 28" x 7" 64910
 ECP088896 HD Stand only, 96" x 28" x 36" 64939
 ECP088899 ABS Shelf for ECP088896 stand 64931

6 ft. Commercial Sink

Holds two 16 x 20 trays. Black. Ships UPS.

ECP087220 Sink only, 72" x 22" x 5" 62710
 ECP088870 HD Stand only, 72" x 22" x 36" 62725

5 ft. Commercial Sink

Holds three 11 x 14 or two 16 x 20 trays. Black. Ships UPS.

ECP086007 Sink only, 60" x 27" x 7" 62610
 ECP088860 HD Stand only, 60" x 28" x 36" 62635
 ECP088869 ABS Shelf for ECP088860 stand 62639

4 ft. Convertible Sink

Can be used as a deep well sink or as a flat sink (with sink insert). Holds four 11 x 14 or two 16 x 20 trays. Ships UPS.



ECP084811 Convertible sink, 48" x 29" x 11" 62410
 ECP088828 HD Stand only, 48" x 29" x 36" 62425

6 ft. Convertible Sink

Holds three 16 x 20 trays. Ships Truck.

ECP62640 Convertible sink, 72" x 29" x 11" 62640
 ECP088872 HD Stand only, 72" x 28" x 36" 62795
 ECP087215 Deep well sink only (without insert) 72" x 29" x 11" 62650

This is only a partial listing of CPM/Delta Products. For a complete listing, request a CPM/Delta catalog. The entire line of CPM/Delta Products is available through Argraph.

PERSONAL SERVICE IS OUR #1 PRIORITY



East: 111 Asia Place, Carlstadt, NJ 07072

(201) 939-7722

FAX: (201) 939-7782

West: 4055 W. Shaw Ave.#105, Fresno, CA 93722

(559) 277-3572

FAX: (559) 277-3574

E-18

CPM/Delta Sink Accessories/Water Filters

ABS Drain Set I

4 piece set is designed for use in photographic sinks. 3" body to 1 1/2" male thread. Includes 3" plug. Recommended over stainless steel for sealing ability and corrosion resistance.

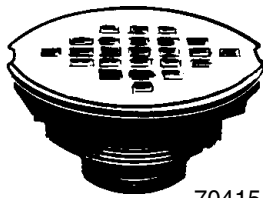

70415

ECP403D ABS Drain Set I

Washer I Washing Well Attachment

Circulates clean water by means of a ported dome which cannot be clogged by prints or film. ABS Drain Set I required.

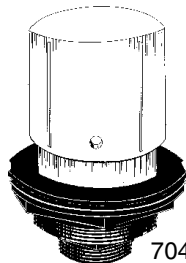

70420

ECP405D Washer

Faucet Set I

Chrome plated brass, 10" spout, hose fitting, non-corrosive, easy to install. Complete directions included. 5 year limited warranty.



70810

ECP409D Faucet Set I

Spray Set I

Designed for cleaning and washing. Spray held, 4 foot hose and faucet attachments.



70510

ECP410D Spray Set I

ABS Sink Plumbing Installation Pacs

Installation Pac I (Single Drain Sink Set)

Faucet (4" center, 8" gooseneck), Drain Waste Set, Connectors, Spray Set I, ABS Drain Set I, 6ft. ABS Tubing

Installation Pac II (Dual Drain Sink Set)

Faucet (4" center, 8" gooseneck), Dual Drain Waste Set, Connectors, Spray Set I, (2) ABS Drain Set I, 6ft. ABS Tubing

ECP452D Single Sink Drain Set 70210

ECP453D Dual Drain Sink Set 70220

Stainless Sink Installation Pac

S/S 5" drain standpipe, (2) four foot 1/2" S/S FIP supply flex-hoses, (4) chrome nipples, (2) chrome shutoff ball valves, black ABS drain waste tail piece, P-Trap, 90° coupling elbow, six foot ABS 1 1/2" tubing.

ECP454D Stainless Sink Installation Pac 61320

Water Filter I - Cold

Easy to install, cleans water. Reinforced Polypropylene, clear transparent body. 3/4" FPT 125°F/125 PSI rated. One 20 micron sediment cartridge included. Five year limited warranty.



ECP426D

ECP427D

Water Filter II - Hot

Glass reinforced nylon. Rated 200°F/200 P.S.I. rated. Red body, 3/4" NPT inlet and outlet. One 20 micron sediment cartridge included. Five year limited warranty.

ECP426D Water Filter I- cold 75310

ECP427D Water Filter II- hot 75320

Water Filter Elements

3/4" standard spun poly cartridge fits 99% of all units. Polypropylene spun (string wound) cartridges. Recommended for photo processing. They have high wet strength and holding capacity. Glued cellulose (paper) cartridges are not recommended for photo applications. Charcoal carbon filters are recommended for color chemistry and drinking water.



ECP081320 box/30, 20 micron 75411

ECP428 pk/2, 20 micron 72200

ECP429 pk/2, 5 micron 72250

ECP424D box/30, 5 micron 75441

ECP75451 box/20, 5 micron 75451

Water Filter Package

Contains: One each hot & cold water filter housings, 2- 20 micron sediment cartridges, 2 shut-off valves & fittings for 3/4" pipe, 1/2" pipe reducers & teflon tape, 2 stainless steel wall brackets, 4ft. of 5/8" clear flexible hose.

ECP080361 Water Filter Package 75550

O-Ring Replacements for Water Filters I & II

ECP080327 4 Buna N rubber O-rings 75530

Water Filter Spanner Wrench- Nylon



ECP430D Water Filter Wrench 75510

Wall Mount Bracket

Stainless steel. Fits 99% of water filters with 3/8" - 3/4" pipe thread.

ECP431D Wall Mount Bracket 75520

FOR FAST DELIVERY CALL TOLL FREE!

EAST
1-888-ARGRAPH
OR 1-800-526-6290

WEST
1-888-WESTARG
OR 1-800-323-9069

Water Temp II

Gives constant temperature readings while water flows. Has on/off control of hot/cold water supply. Fits 99% of faucets, swivels 360° degrees. Has water strainer in fitting. Large 3" dual scale thermometer, adjustable needle, probe contact of thermometer built-in. Ready to be inserted into plumbing. 5 year warranty.



ECP445 Delta Water Temp II

65010

Flo-Temp Thermometer Well

Attaches to faucet (or with adapter). Built-in filter. Holds Premier/Samigon/Weston type dial thermometers. Guarantees temperature control at the faucet. Operator adjusts temperature at water source. Angled for easy reading. Nylon with brass fittings.

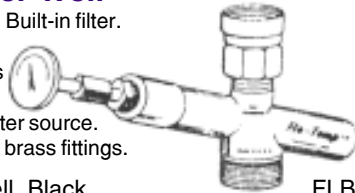

EPF901 Thermometer Well, Black

FLB

Aqualizer

Magnetic water conditioner & lime fighter. In line for 70% more strength. Two in-Line Force Fields. Stops algae. No maintenance. As cold water passes through the intense magnetic field created by the Aqualizer the characteristics of the water are changed so that the algae and lime will no longer be a problem. 3/4" MPT.

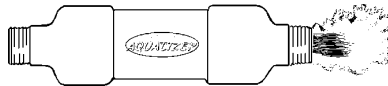

ECP656D Water Conditioner/Lime Fighter

79010

Flowmeter I

Conserves water. Rated 150 PSI. Stainless steel float and guide rod. Extremely accurate $\pm 2\%$. Extra high pressure, space age flowmeter with Buna N, O Rings. Accurately measures .5 to 5 GPM of water. Saves water, pays for itself. 1/2" MPT.



ECP437D Flowmeter I

78110

Vacuum Breaker I

Meets plumbing codes and EPA compliance regs. Prevents backflow. Anti-siphon 1/2" IPC. Chrome.



ECP434D Vacuum Breaker I

78210

Hose Bibb Vacuum Breaker II

Screw on spout. Anti-siphon prevents reverse flow of contaminated water back to portable water supply. Required by most U.S. City plumbing Codes and EPA Compliance Regs. Fire, freezing, natural disasters, accidents, and broken or cracked pipes below level of vacuum breaker can siphon chemicals, solvents, etc. into water system. GHT fittings on both ends.



ECP435D Hose Bibb Vacuum Breaker II

78230

Water Temperature Control Panels

All models are fully assembled, plumbed, and lab tested. Controls are 1/2" FPT. 3" dial thermometer with calibration screw. Some units include a vacuum breaker which prevents backflow and stop check valves which provide one-way flow of water. Models 15 and 25 have 3/4" GHT for water outlets. Models 800 and 1000 have 1/2" FPT for water outlets.

Model 15: Manual Water Panel

- Economical temperature control
- Hot & cold water ball valves
- Flow control ball valve
- 1/2" NPT inlet connections, 3/4" GHT outlet
- 20 micron water filter cartridge

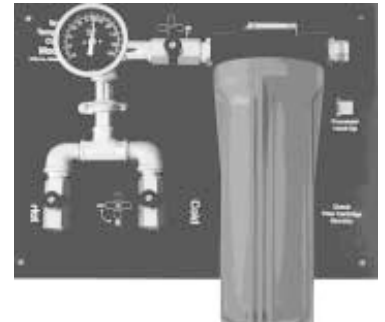

ECP468D Manual, model 15

65115

Model 25

- Thermostatic mixing valve for accurate temperature control
- Flow control ball valve
- 1/2" NPT inlet connections, 3/4" GHT outlet
- Adjustable spring check valves
- 20 micron water filter cartridge



ECP470D Model 25

65125

Model 800

- Hot & cold water filtration
- Vacuum breaker
- .5 - 5 GPM flowmeter
- Adjustable spring check valves
- Two- 20 micron water filter cartridges

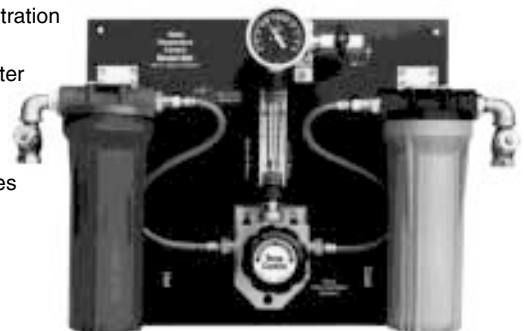

ECP466D Model 800 water control, Regular Flow

66800

ECP472D Model 800 water control, Low Flow

65150

PERSONAL SERVICE IS OUR #1 PRIORITY



East: 111 Asia Place, Carlstadt, NJ 07072

(201) 939-7722

FAX: (201) 939-7782

West: 4055 W. Shaw Ave. #105, Fresno, CA 93722

(559) 277-3572

FAX: (559) 277-3574

E-20 Water Control Accessories/Processors

CPM/Delta ECO 1™ Basic Unit Thermostatic Water Control

Protects the environment with one way valves, conserves water with low flow mixers, and uses non-chromium and non-toxic UL sealers.

- Two adjustable spring checkstops for one way water flow
- 3" dial thermometer rated 30°F to 130°F with recalibration screw
- One volume control ball valve
- High impact ABS plastic housing



ECP095000	ECO 1 Basic Unit, Regular Flow, 1-7 GPM	65155
ECP65160	ECO 1 Basic Unit, Low Flow, 5-1.5 GPM	65160

ECO Vacuum Breaker with Fittings

Prevents backflow of water or chemistry into potable water supply. Meets all U.S. and Canadian plumbing codes.

ECP095100	ECO Vacuum Breaker	65165
-----------	--------------------	-------

CPM/Delta BLACK OUT™ Power Exhaust Fan

Keep your workspace fresh and properly ventilated for safety and comfort. The fan draws a complete change of air every 3 minutes in a 10' x 10' room.

Oversized fan blades and thermally protected motor are rated at 300 CFM.

Computer designed baffles in 12" x 12" louvers allow air exchange to flow freely and still maintain a totally light-tight environment.

For extra protection the interiors of all louvers are fully painted with matte black. Components are UL listed. 6" standard duct.



ECP691	Fan/Louvers-Ductwork	50020
--------	----------------------	-------

Delta Light-tight Louvers

Four light tight louvers complete the ventilation system.

Louvers should be installed in the wall (or door) opposite the fan assembly to provide a light tight air inlet and free air flow through the darkroom.



ECP695	12 x 12 Light-tight louvers	50060
ECP696	12 x 24 Light-tight louvers	50070
ECP311202	12 x 12 Filtered Light-tight louvers	50040
ECP311204	12 x 24 Filtered Light-tight louvers	50050

CPM/Delta Electrostatic Air Scrubber™ Portable

Cleans and removes 97% of airborne particles of bacteria, smoke, dust, mold, pollen and other contaminants. A Protectair prefilter removes larger particles and a permanent UL approved, heavy duty, self-charging electrostatic filter removes particles as small as one micron. A monthly flush with clean water returns filters to like- new condition. Cleans a 20 ft. x 20 ft. area more than 5 times per hour. 10½" square. Includes carrying handle and 8 ft. heavy duty cord.



ECP310005	Electrostatic Air Scrubber	50110
-----------	----------------------------	-------

FOR FAST DELIVERY CALL TOLL FREE!

EAST
1-888-ARGRAPH
OR 1-800-526-6290

WEST
1-888-WESTARG
OR 1-800-323-9069